

Peak Emission Wavelength: 470nm

The MTE4047C2-UB consists of a 470nm high output die in a water-clear plastic molded package. Custom package solutions and sorting are available.

FEATURES

- > High Output Power
- > High Reliability
- > Compact

APPLICATIONS

- > Color Sensor (Money-bill)
- > Paper Sensor (Money Bill)

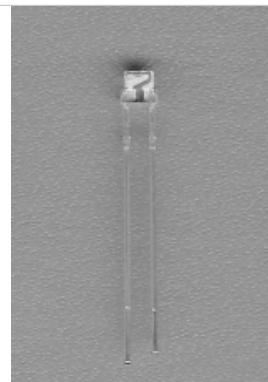

Absolute Maximum Ratings (Ta=25°C)



ITEMS	SYMBOL	RATINGS	UNIT
Forward Current	IF	50	mA
Forward Current (Pulse)*1	IFP	0.5	A
Reverse Voltage	VR	5	V
Power Dissipation	PD	140	mW
Operating Temperature Range	Topr	-20 ~ +80	°C
Storage Temperature Range	Tstg	-30 ~ +100	°C
Lead Soldering Temperature*2	Tls	260	°C

*1: Tw=10μsec, T=10msec; *2: Time 5 Sec max, Position: Up to 3mm from the body.

Electrical & Optical Characteristics (Ta = 25°C)

ITEMS	SYMBOL	CONDITIONS	MIN	TYP	MAX	UNIT
Power Output	PO	IF=20mA	--	14.5	--	mW
Forward Voltage	VF	IF=20mA	--	3.0	3.5	V
Reverse Current	IR	VR=5V	--	--	100	μA
Peak Emission Wavelength	λp	IF=20mA	--	470	--	nm
Spectral Line Half Width	Δλ	IF=20mA	--	35	--	nm
Half Intensity Beam Angle	Θ	IF=20mA	--	±45	--	deg

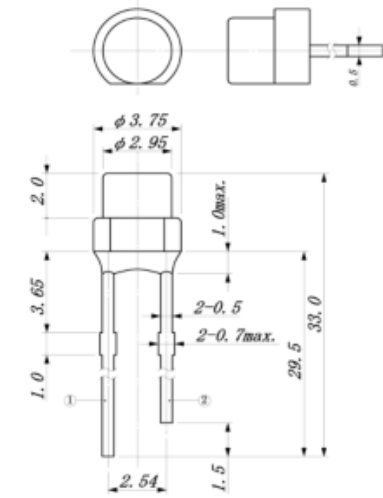

① Anode ② Cathode
Dimensions (Unit:mm)

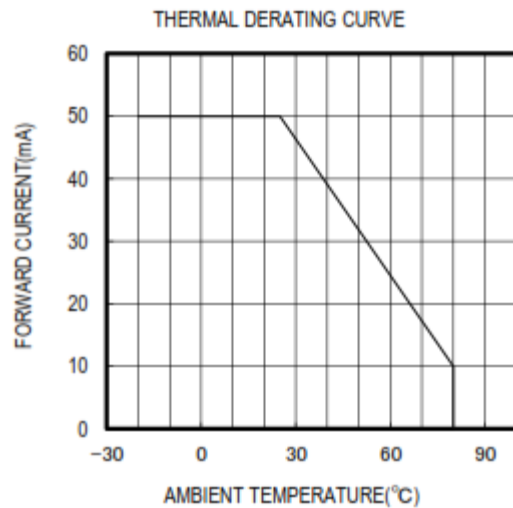
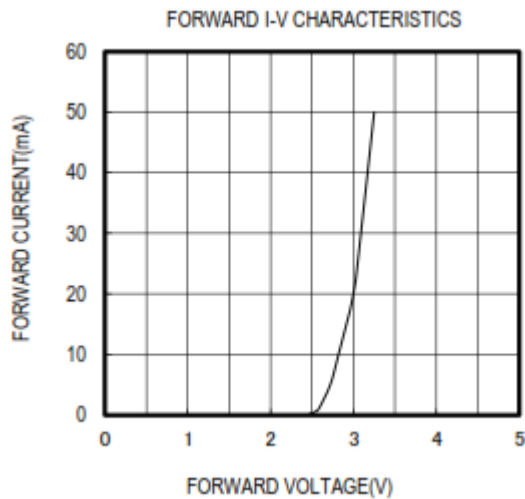
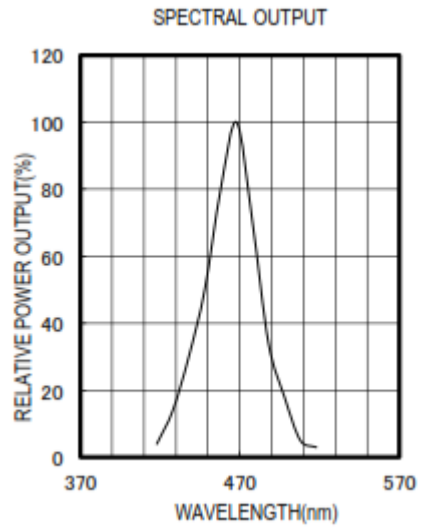

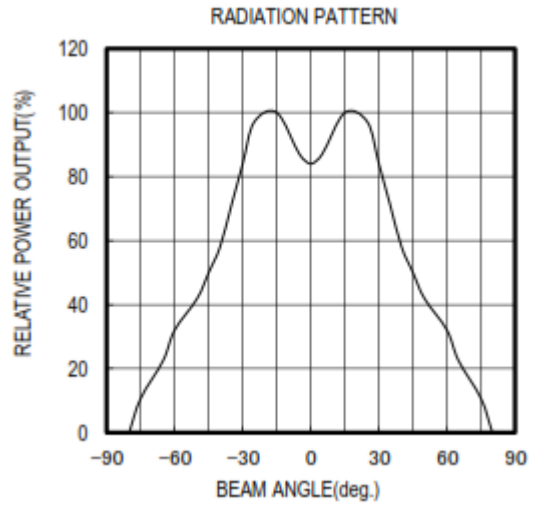
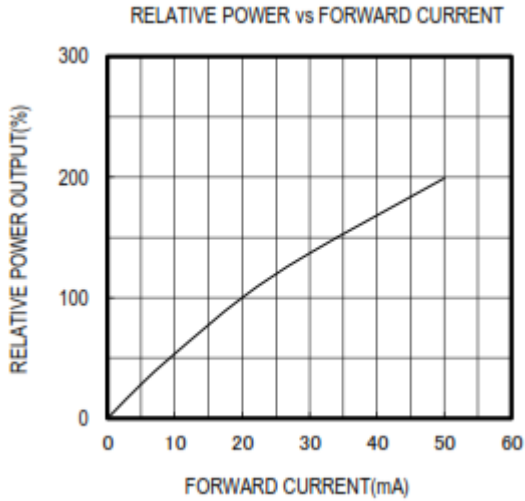

The information contained herein is subject to change without notice.

2024-03-12